

© 2013 Essentra Components. All rights reserved.  
 Registered in England, Company No. 547495.  
 Registered Office: Essentra plc  
 Langford Locks, Kidlington, Oxford, OX5 1HX

Condition of Sale can be found on our website: [essentra.com](http://essentra.com).

Essentra Components does not warrant that the files will be error free and may create new versions ("Upgrades") at any time, which may correct such errors. Essentra Components has no obligation to notify you of such upgrades. Any upgraded file will be published to the website, when it becomes available.

You are not permitted to load any of the files on to a network server for the purposes of distribution to one or more other computer(s) on that network or to effect such distribution. Essentra Components shall not be liable for any loss or damage whatsoever or however caused, arising directly or indirectly from the use of the files.

**UNCONTROLLED COPY**

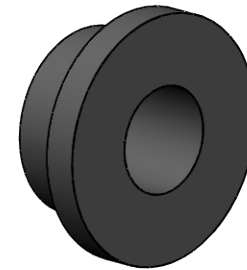
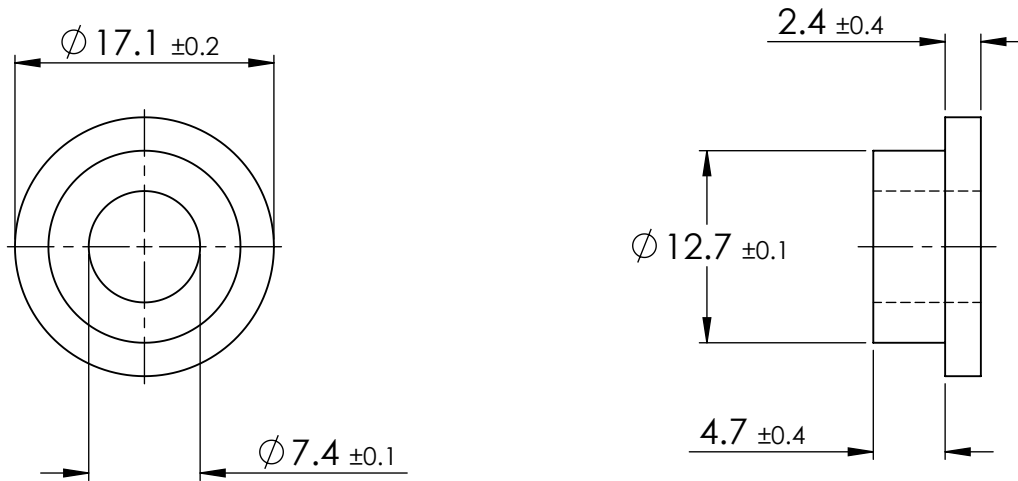

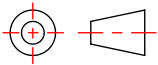
STATUS		<b>APPROVED DRAWING</b>	
UNLESS OTHERWISE STATED			
ALL DIMENSIONS IN mm		DO NOT SCALE	
LINEAR TOLERANCE		THIRD ANGLE PROJECTION	
SIZE	(0) (0.0) (0.00)	 ANGULAR TOLERANCE $\pm 0.5$ DEGREES UNSPECIFIED RADII 0.25mm DRAFT ANGLE 0.5 DEGREES DIMENSIONS IN PARENTHESIS ( ) ARE FOR REFERENCE ONLY	
0-10	$\pm 0.5$ $\pm 0.15$ $\pm 0.10$		
>10-30	$\pm 0.5$ $\pm 0.20$ $\pm 0.15$		
>30-50	$\pm 0.5$ $\pm 0.30$ $\pm 0.20$		
>50-100	$\pm 0.8$ $\pm 0.50$ $\pm 0.25$		
>100-200	$\pm 1.5$ $\pm 0.80$ $\pm 0.40$		
>200-300	$\pm 2.0$ $\pm 1.20$ $\pm 0.80$		
>300-500	$\pm 3.0$ $\pm 2.00$ $\pm 1.00$		
>500	$\pm 5.0$ $\pm 3.00$ $\pm 1.50$		
ITEM CODE	20486594	CREATE DATE	20/03/2025
LEGACY CODE	12SWS2508B	MATERIAL	PA66
-	-	COLOUR	BLACK
-	-	FINISH	-
TITLE: SHOULDER WASHER -			
DWG. No.	20486594	SCALE	ISSUE
		2:1	1
		SHEET	1 of 2

© 2013 Essentra Components. All rights reserved.  
 Registered in England, Company No. 547495.  
 Registered Office: Essentra plc  
 Langford Locks, Kidlington, Oxford, OX5 1HX

Condition of Sale can be found on our website: [essentra.com](http://essentra.com).

Essentra Components does not warrant that the files will be error free and may create new versions ("Upgrades") at any time, which may correct such errors. Essentra Components has no obligation to notify you of such upgrades. Any upgraded file will be published to the website, when it becomes available.

You are not permitted to load any of the files on to a network server for the purposes of distribution to one or more other computer(s) on that network or to effect such distribution. Essentra Components shall not be liable for any loss or damage whatsoever or however caused, arising directly or indirectly from the use of the files.

**UNCONTROLLED COPY**

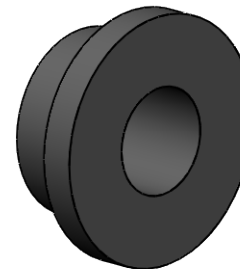
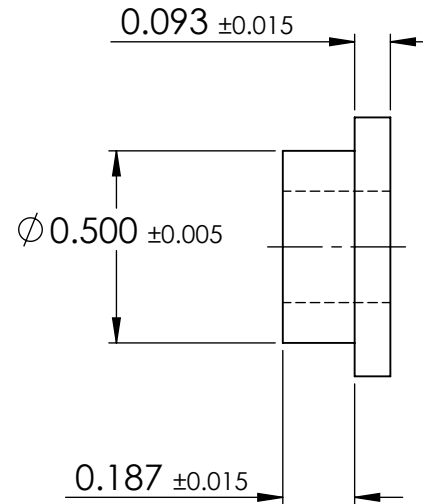
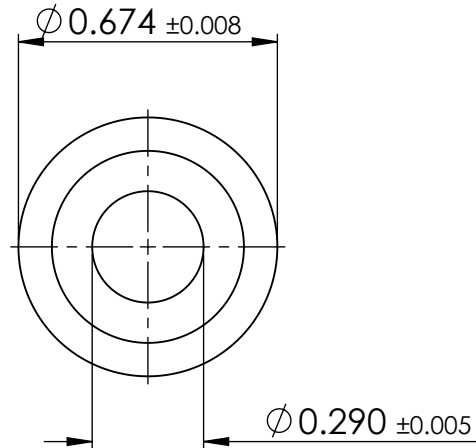

STATUS **APPROVED DRAWING**

**UNLESS OTHERWISE STATED**

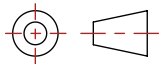
ALL DIMENSIONS IN inches			DO NOT SCALE
LINEAR TOLERANCE			THIRD ANGLE PROJECTION
SIZE	(0.00)	(0.000)	(0.0000)
0 - 0.394	±0.020	±0.006	±0.004
>0.394 - 1.181	±0.020	±0.008	±0.006
>1.181 - 1.969	±0.020	±0.012	±0.008
>1.969 - 3.937	±0.031	±0.020	±0.010
>3.937 - 7.874	±0.059	±0.031	±0.016
>7.874 - 11.811	±0.079	±0.047	±0.031
>11.811 - 19.685	±0.118	±0.079	±0.039
>19.685	±0.197	±0.118	±0.059
			 ANGULAR TOLERANCE ±0.5 DEGREES UNSPECIFIED RADII 0.25mm DRAFT ANGLE 0.5 DEGREES DIMENSIONS IN PARENTHESIS ( ) ARE FOR REFERENCE ONLY

ITEM CODE	20486594	20/03/2025	CREATE DATE
LEGACY CODE	12SWS2508B	PA66	MATERIAL
-	-	BLACK	COLOUR
-	-	-	FINISH

TITLE:  
**SHOULDER WASHER**

DWG. No.	20486594	SCALE	ISSUE
		2:1	1
		SHEET	2 of 2